



XT91 - 6



XT81 - 14



XT82 - 22



XT71 - 28

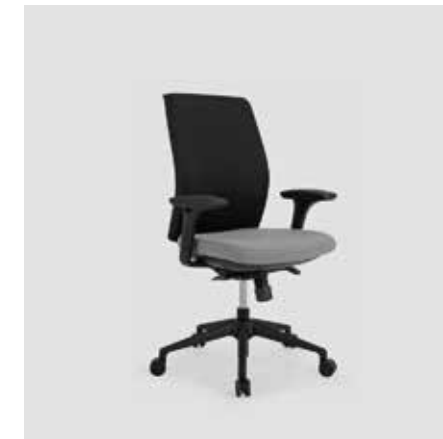

XT62 - 30



XT64 - 40



XT51 - 48

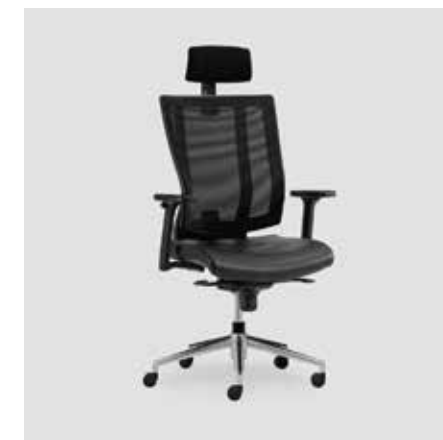

XT41 - 54

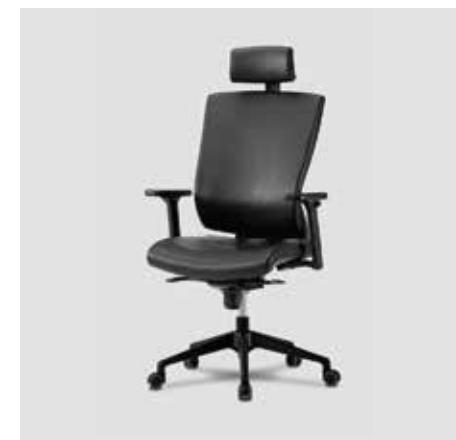

XT42 - 62



XT31 - 68



XT23 - 76



www.riva-office.com

XT COLLECTION

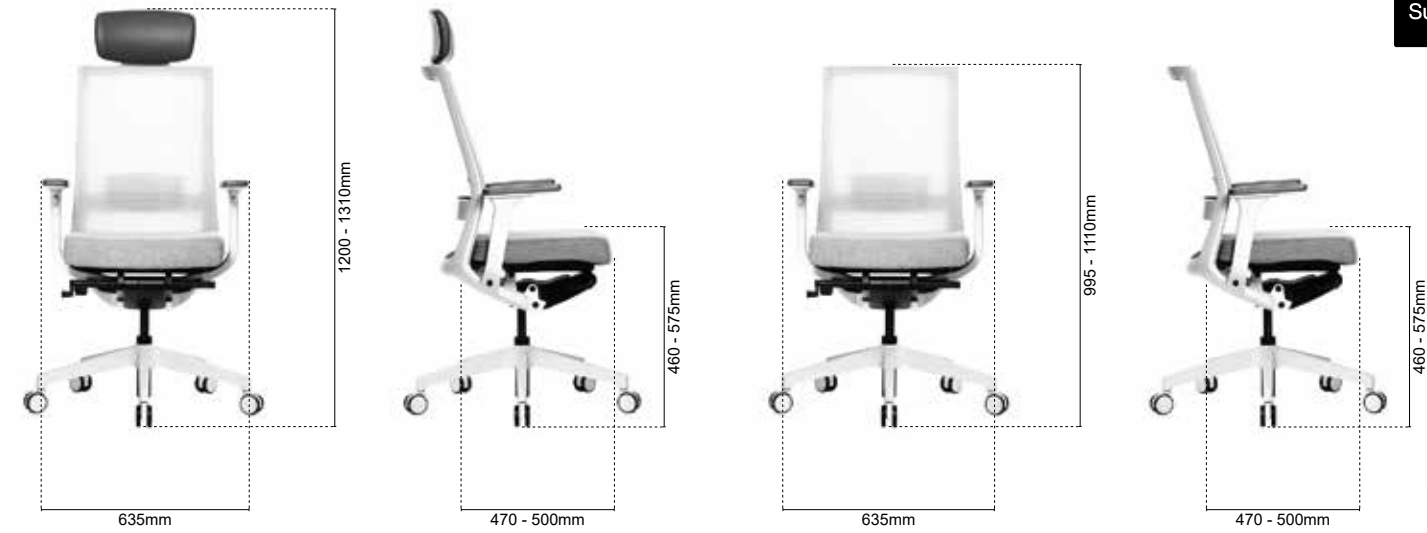

CARACTERÍSTICAS / CHARACTERISTICS / CARÁCTER / FONCTIONNALITÉS



Braços reguláveis 3D.
3D adjustable armrests.
Apoyabrazos regulables 3D.
Accoudoirs ajustable 3D.



Assento ajustável em profundidade.
Adjustable depth seat.
Asiento ajustable en profundidad.
Siège réglable en profondeur.



Apoio lombar flexível, ajustável em altura.
Flexible lumbar support, height adjustable.
Apoyo lumbar flexible, ajustable en altura.
Support lombaire flexible, réglable en hauteur.

CORPO / BODY / CUERPO / CORPS

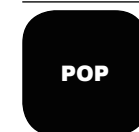

POP

Preto
Black
Negro
Noir

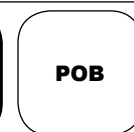

POB

Branco
White
Blanco
Blanc

XT91





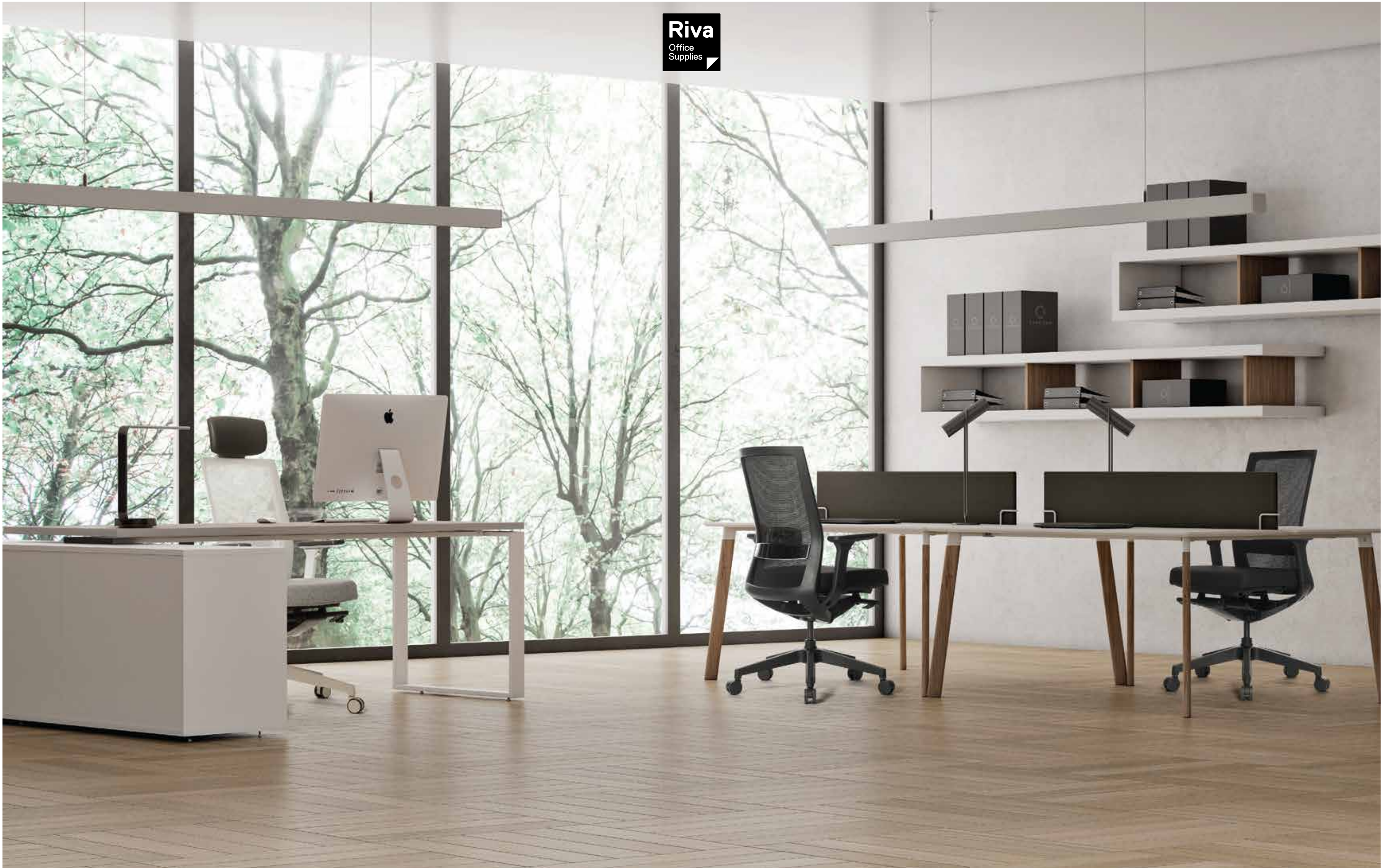

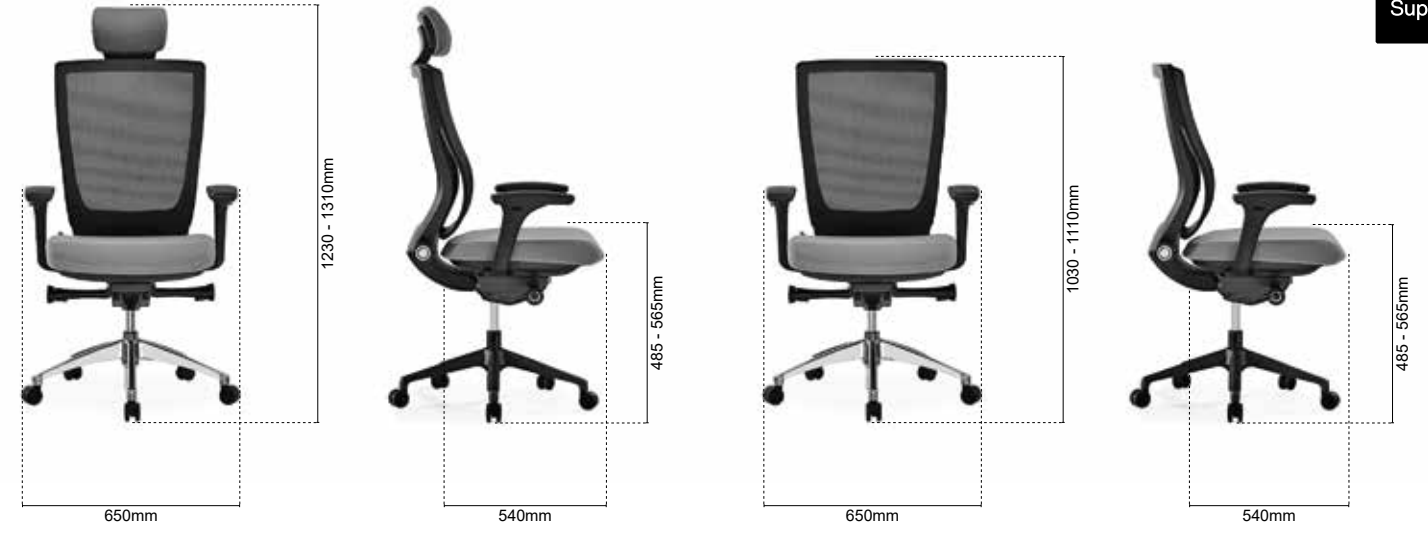

XT81

CARACTERÍSTICAS / CHARACTERISCS / CARÁCTER / FONCTIONNALITÉS



Bracos reguláveis 2D/ 3D.
2D/ 3D adjustable armrests.
Apoyabrazos regulables 2D/ 3D.
Accoudoirs ajustable 2D/ 3D.



Assento ajustável em profundidade.
Adjustable depth seat.
Asiento ajustable en profundidad.
Siège réglable en profondeur.



Apoio lombar ajustável, Fit System.
Fit System adjustable lumbar support.
Apoyo lumbar regulable Fit System.
Appui lombaire ajustable Fit System.

CORPO / BODY / CUERPO / CORPS



POP

Preto
Black
Negro
Noir



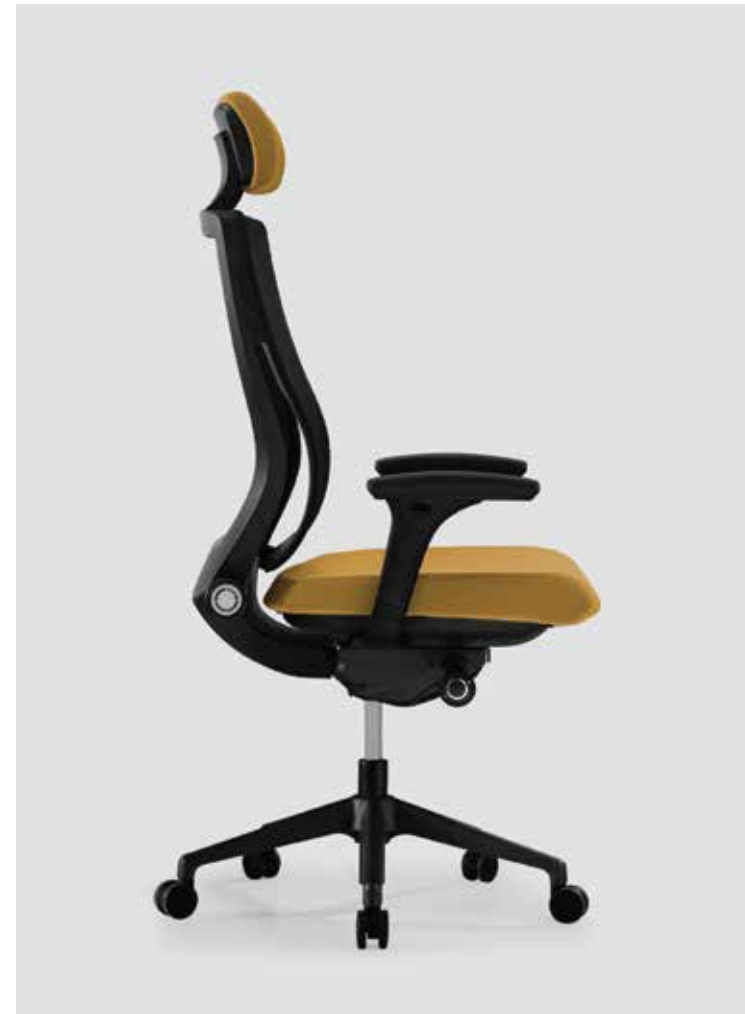





XT82

CARACTERÍSTICAS / CHARACTERISCS / CARÁCTER / FONCTIONNALITÉS



Braços reguláveis 2D/3D.
2D/3D adjustable armrests.
Apoyabrazos regulables 2D/3D.
Accoudoirs ajustable 2D/3D.



Assento ajustável em profundidade.
Adjustable depth seat.
Asiento ajustable en profundidad.
Siège réglable en profondeur.



Apoio lombar ajustável, Fit System.
Fit System adjustable lumbar support.
Apoyo lumbar regulable Fit System.
Appui lombaire ajustable Fit System.

CORPO / BODY / CUERPO / CORPS



POP

Preto
Black
Negro
Noir





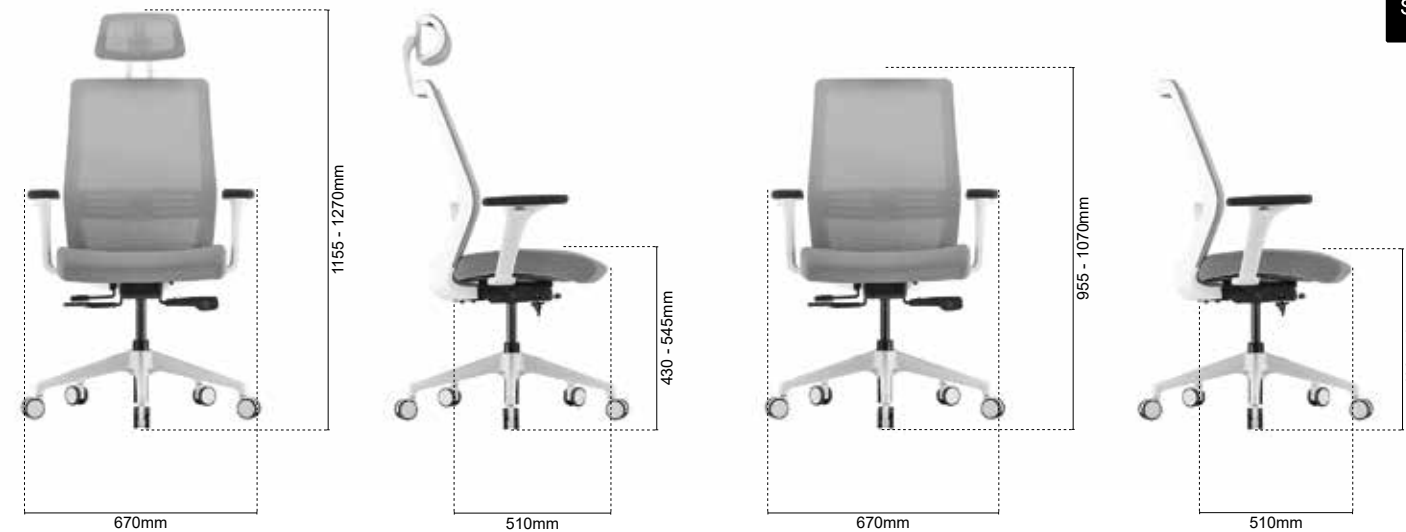

CARACTERÍSTICAS / CHARACTERISCS / CARÁCTER / FONCTIONNALITÉS



Braços reguláveis 2D (Preto)/ 3D.
2D (Black)/ 3D adjustable armrests.
Apoyabrazos regulables 2D (Nero)/ 3D.
Accoudoirs ajustable 2D (Noir)/ 3D.



Assento ajustável em profundidade.
Adjustable depth seat.
Asiento ajustable en profundidad.
Siège réglable en profondeur.



Apoio lombar regulável em profundidade.
Depth adjustable lumbar support.
Soporte lumbar regulable en profundidad.
Soutien lombaire ajustable en profondeur.

CORPO / BODY / CUERPO / CORPS

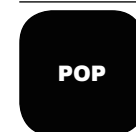

POP

Preto
Black
Negro
Noir

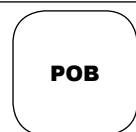

POB

Branco
White
Blanco
Blanc

XT71







XT62

CARACTERÍSTICAS / CHARACTERISTICS / CARÁCTER / FONCTIONNALITÉS



Bracos reguláveis 2D/3D.
2D/3D adjustable armrests.
Apoyabrazos regulables 2D/3D.
Accoudoirs ajustable 2D/3D.

CORPO / BODY / CUERPO / CORPS

POP

Preto
Black
Negro
Noir







XT64

CARACTERÍSTICAS / CHARACTERISCS / CARÁCTER / FONCTIONNALITÉS



Bracos reguláveis 2D (Preto)/ 3D.
2D (Black)/ 3D adjustable armrests.
Apoyabrazos regulables 2D (Negro)/ 3D.
Accoudoirs ajustable 2D (Noir)/ 3D.

CORPO / BODY / CUERPO / CORPS

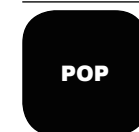

POP

Preto
Black
Negro
Noir



POB

Branco
White
Blanco
Blanc







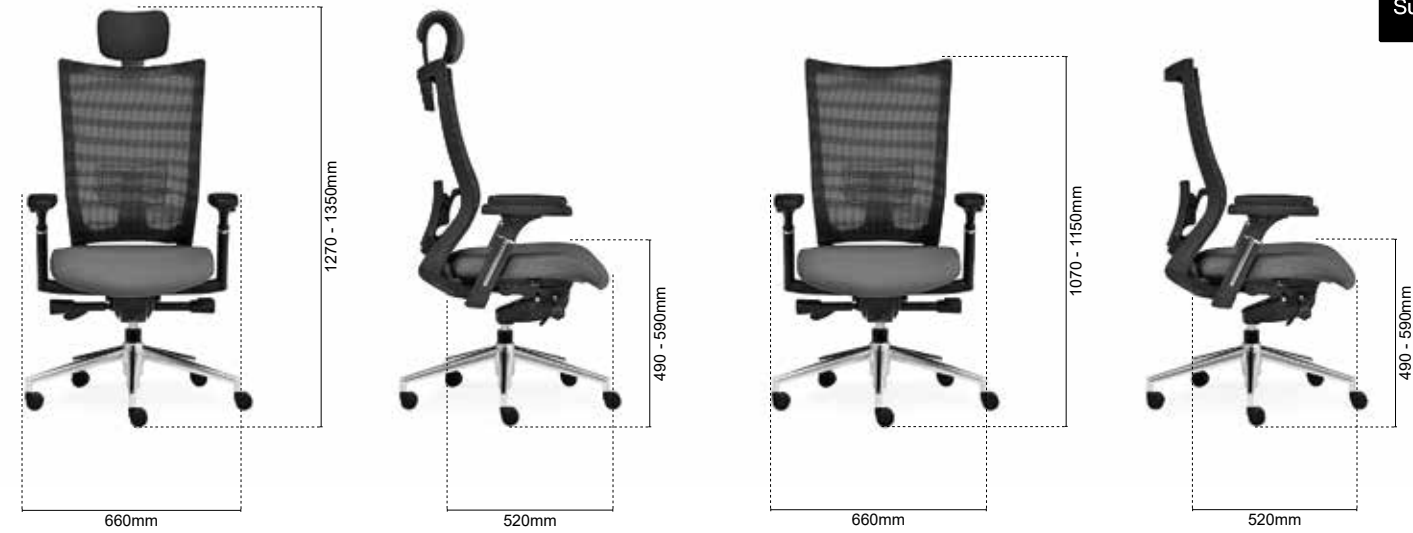

XT51

CARACTERÍSTICAS / CHARACTERISTICS / CARÁCTER / FONCTIONNALITÉS

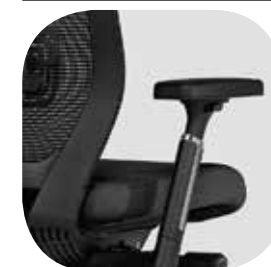

Braços reguláveis 3D.
3D adjustable armrests.
Apoyabrazos regulables 3D.
Accoudoirs ajustable 3D.



Assento ajustável em profundidade.
Adjustable depth seat.
Asiento ajustable en profundidad.
Siège réglable en profondeur.



Apoio lombar regulável em profundidade.
Depth adjustable lumbar support.
Soporte lumbar regulable en profundidad.
Soutien lombaire ajustable en profondeur.

CORPO / BODY / CUERPO / CORPS

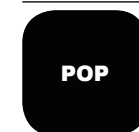

POP

Preto
Black
Negro
Noir





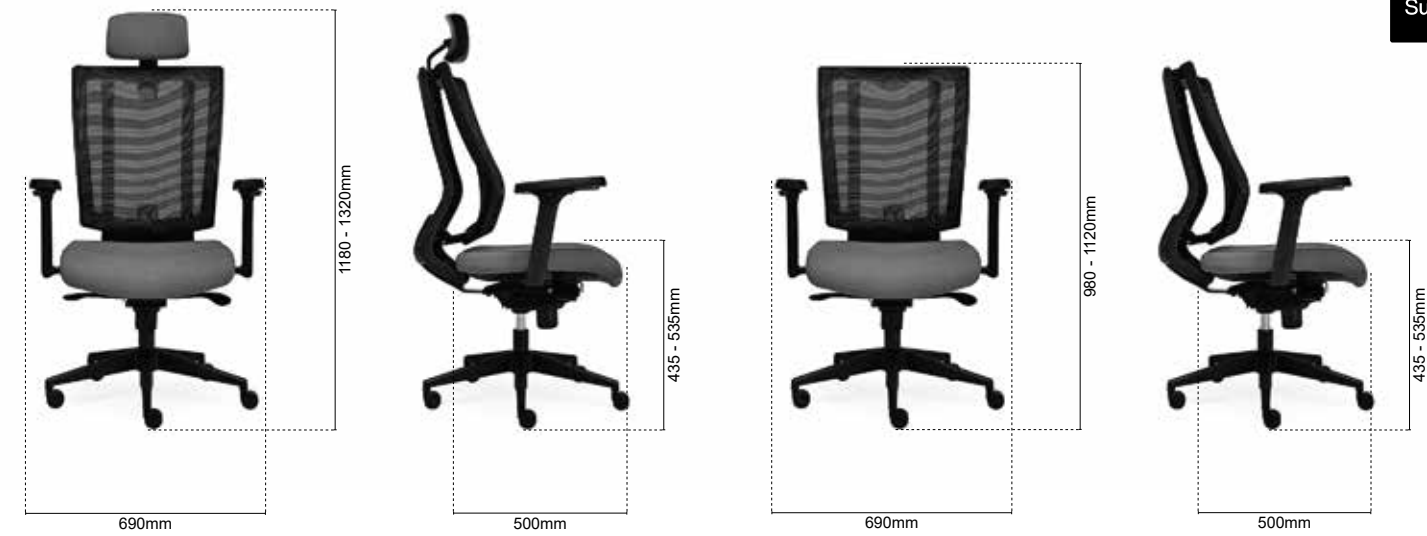

CARACTERÍSTICAS / CHARACTERISCS / CARÁCTER / FONCTIONNALITÉS



Bracos reguláveis 2D/3D.
2D/3D adjustable armrests.
Apoyabrazos regulables 2D/3D.
Accoudoirs ajustable 2D/3D.



Apoyo lumbar auto ajustável.
Self adjustable lumbar support.
Soporte lumbar auto ajustable.
Appui lombaire auto réglable.



Sistema Twist.
Twist System.
Sistema Twist.
System Twist.

CORPO / BODY / CUERPO / CORPS



Preto
Black
Negro
Noir

XT41



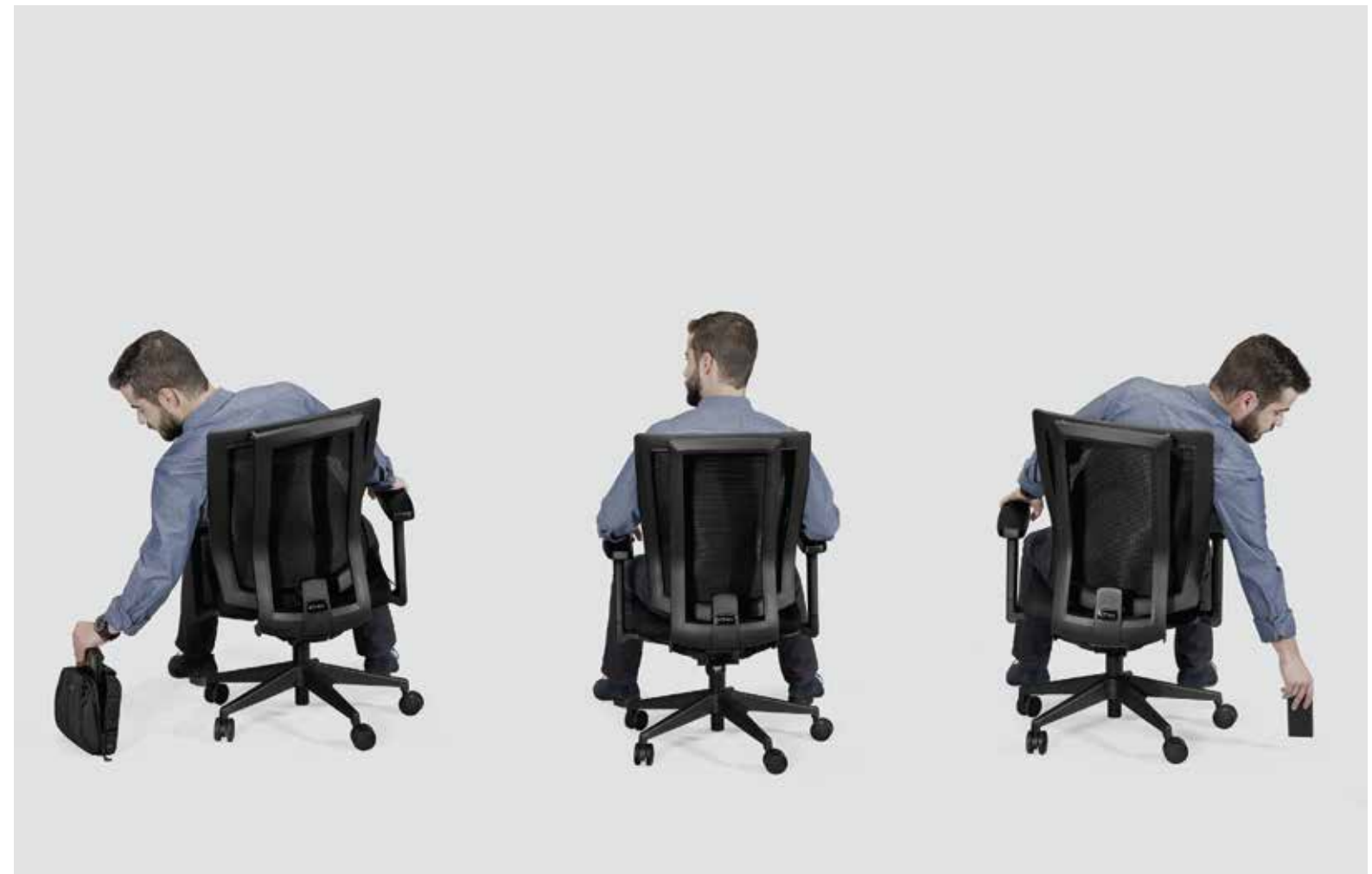





XT42

CARACTERÍSTICAS / CHARACTERISTICS / CARÁCTER / FONCTIONNALITÉS



Bracos reguláveis 2D/3D.
2D/3D adjustable armrests.
Apoyabrazos regulables 2D/3D.
Accoudoirs ajustable 2D/3D.



Apoio lombar auto ajustável.
Self adjustable lumbar support.
Soporte lumbar auto ajustable.
Appui lombaire auto réglable.



Sistema Twist.
Twist System.
Sistema Twist.
System Twist.

CORPO / BODY / CUERPO / CORPS



Preto
Black
Negro
Noir





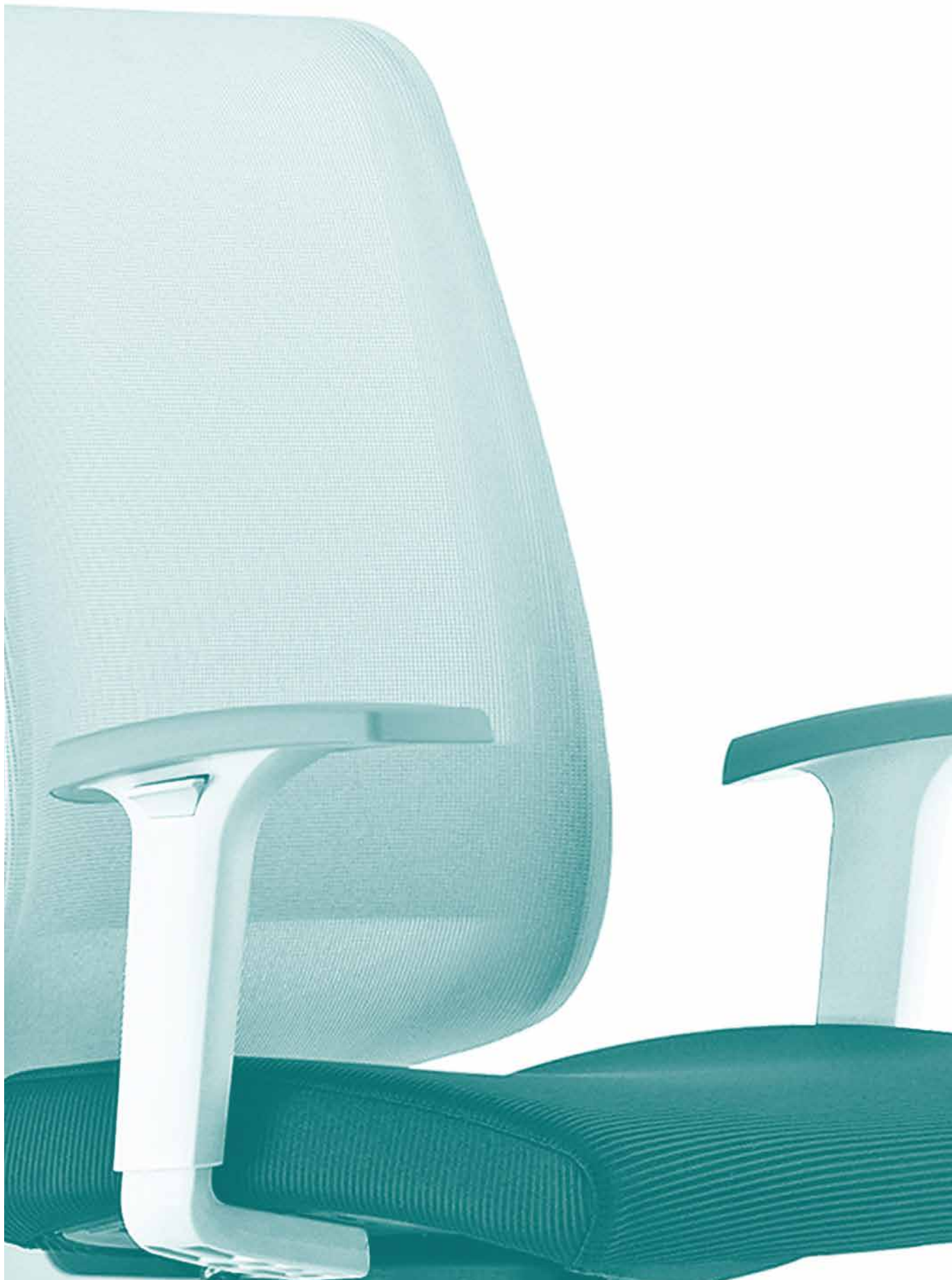

CARACTERÍSTICAS / CHARACTERISCS / CARÁCTER / FONCTIONNALITÉS



Bracos fixos e reguláveis.
Fixed and adjustable armrests.
Apoyabrazos regulables y fijos.
Accoudoirs ajustable et fixes.



Apoio lombar regulável em altura.
Height adjustable lumbar support.
Soporte lumbar regulable en altura.
Soutien lombaire ajustable en hauteur.

CORPO / BODY / CUERPO / CORPS



POP

Preto
Black
Negro
Noir

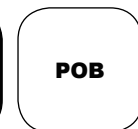

POB

Branco
White
Blanco
Blanc







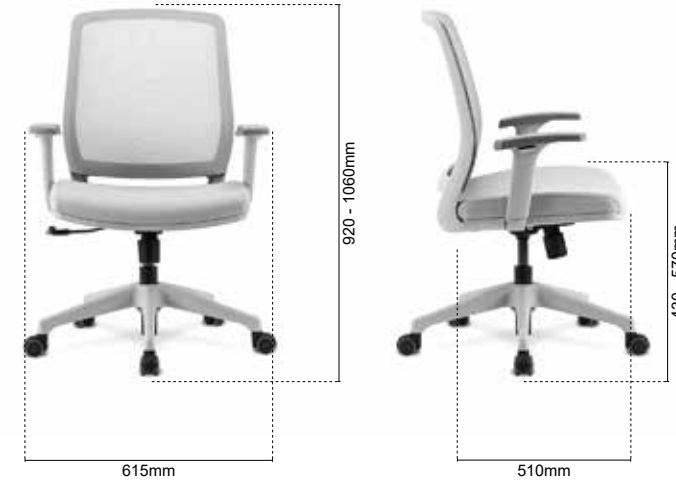

XT23

CARACTERÍSTICAS / CHARACTERISTICS / CARÁCTER / FONCTIONNALITÉS



Bracos fixos e reguláveis.
Fixed and adjustable armrests.
Apoyabrazos regulables y fijos.
Accoudoirs ajustable et fixes.



Apoio lombar.
Lumbar support.
Soutien lombaire.
Soutien lombaire.

CORPO / BODY / CUERPO / CORPS



POP

Preto
Black
Negro
Noir



POG

Cinza
Grey
Gris





WORK HARD, PLAY HARDER.

Os acabamentos dos produtos podem ser alterados sem aviso prévio, por motivos técnicos ou devido a modificações qualitativas de produção. As cores, tonalidades e dimensões são meramente indicativas.

The products finishes and dimensions can be altered without prior notice, for technical production reasons or due to production quality modifications. The clours and tones are only indicative.

Los acabados de los productos pueden ser cambiados sin aviso previo, debido a detalles técnicos ò a modificaciones cualitativas en la producción. Los colores y dimensiones son meramente indicativos.

Le produit finit et dimensions peuvent être modifiées sans avis préalable, pour des raisons techniques ou même à cause des modifications qualitatives au niveau de la production.

A empresa reserva-se o direito de modificar ou alterar em qualquer momento os produtos sem aviso prévio.

The company reserves the right to alter or change any product show at any given time, even without prior notice.

La firma se reserva el derecho a modificar o cambiar unilateralmente, en cualquier momento y sin aviso previo los productos.

L'entreprise se réserve le droit de modifier ou changer à tout moment les produits sans préavis.



www.riva-office.com



+351 253 616 209



+351 926 270 292



orcamentos@riva-office.pt

